

Break Forming

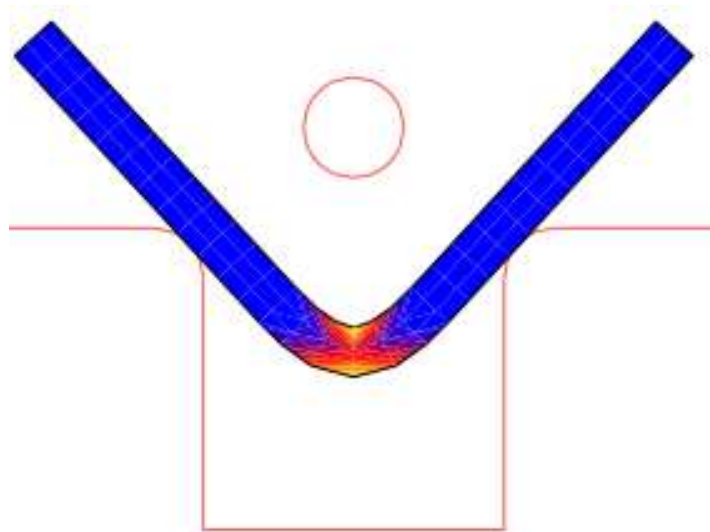

1. File: New

2. Geometry & Mesh

2.1 Basic Manipulation: Length Unit: Inch

2.2 Coordi Systems: Grid

2.3 Coordinat Systems: Edit

a) V Domain: -0.7 0.4

b) Ok

2.4 Basic Manipulation: Geometry & Mesh

a) Curves A

- point(1, 0, 0) Enter
- point(0.3, 0, 0) Ente
- point(0.3, 0, 0) Enter
- point(0.3, -0.6, 0) Ente
- point(0.3, -0.6, 0) Ent
- point(-0.3, -0.6, 0) Enter
- point(-0.3, -0.6, 0) Enter
- point(-0.3, 0, 0) Enter

- point(-0.3, 0, 0) Enter

- point(-1, 0, 0) Enter

b) Curves Type: Fillet

c) Curves Add

- Select right horizontal and right vertical curve
- fillet radius: 0.1 Enter
- Select left horizontal and left vertical curve
- fillet radius 0.1 En

d) Curves Type: Circle Cen/Rad

- CEnter Point: 0 0.2 0 Enter
- Radius: 0.1 Enter

e) Elements A

- node(-0.9,0,0) Enter
- node(0.9,0,0) Enter
- node(0.9,0.1,0) Ente
- node(-0.9,0.1,0) Enter

f) Ok

2.5 Operations: Subdivide

a) Divisions: 30 3 1

b) Elements

- All Existi

c)

2.6 Operatio Sweep

a) All

b) Ok

2.7 Basic Manipulation: Renumber

a) All Geometry And Mesh

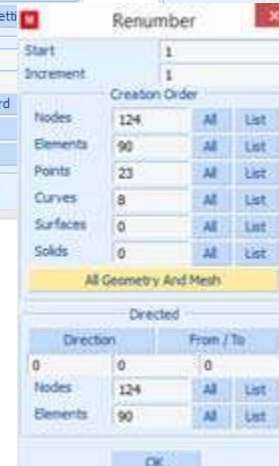
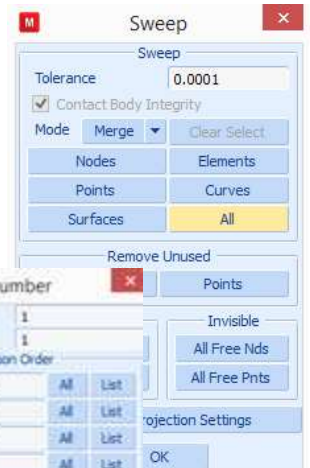
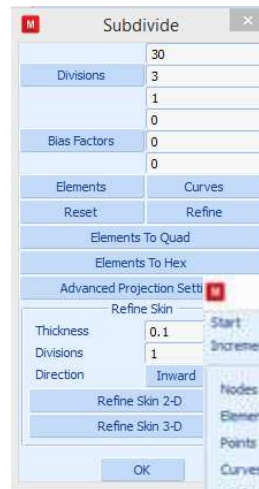
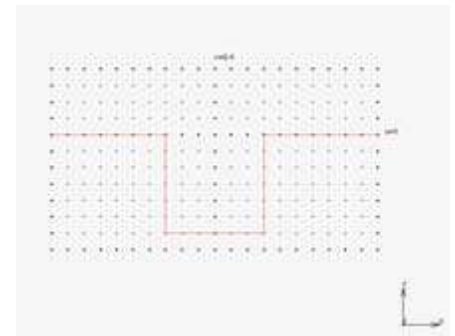
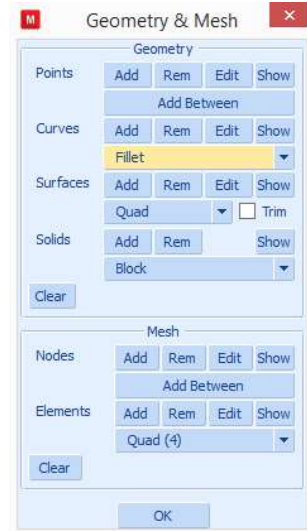
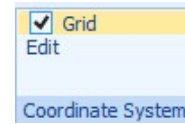

b) Ok

2.8 Coordinate Systems: Grid Off

3. Boundary Conditions

3.1 New (Structural): Fixed Displa

a) Displac X: 0

b) Nodes Add

- Select nodes along $x = 0$, without node touching the circle
- All Selected

c) Ok

4. Tables & Coord. Syst.

4. New: 1 Independent Variable

a) Type

- eq_plastic_strai

- Ok

b) Formula: $5e4*(1+v1^{0.6})$

c) Fit

d) Ok

4.2 New: 1 Independent Variable

a) Type

- time
- Ok

b) Add

- Enter independent va V1 value:

0 0 Enter
 0.5 -0.2 E → **0.5 -0.3**
 1 0 Enter

c) Fit

d) Ok

5. Material Propertie

5.1 New: Finite Stiffness Region: Standard

a) Young's Modulus: $3e7$

b) Poisson's Ratio: 0.

c) Plastic

- Yield Stress 1
- Table
- table
- Ok

- Ok

e) Elements Add

- All Exi

e) Ok

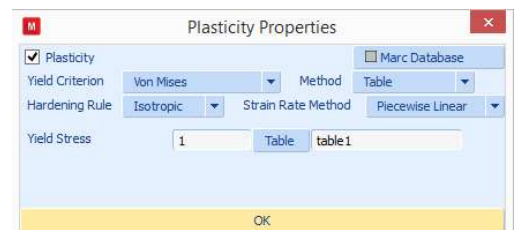
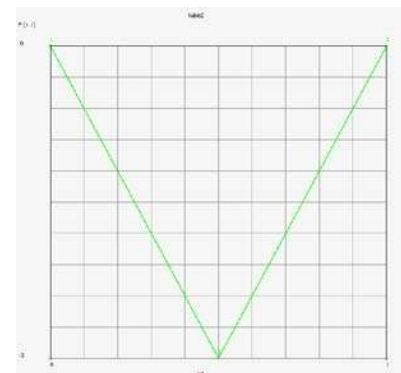
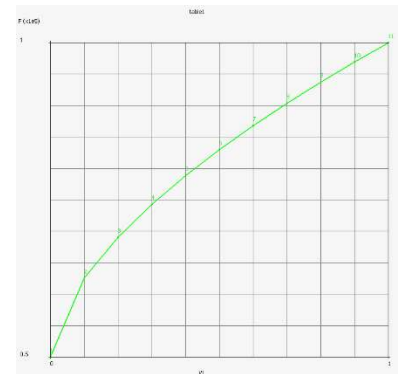
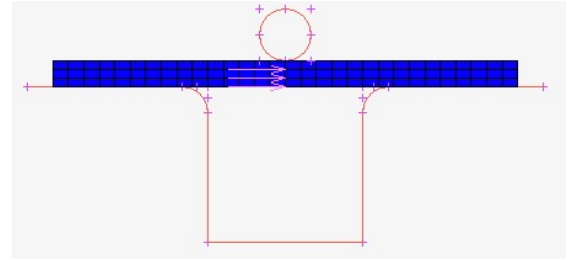

6. Contact

6.1 New: Meshed (Deformable)

- a) Elements Ad
 - All Existing
- b) Ok

6.2 New: Geometric

- a) Body Control: Position
- b) Paramete
 - Position Y: 1
 - Table
 - table2
 - Ok
- Ok
- c) Curves Add

- Select cylinde
- All Selected

- d) Ok

6.3 New: Geometric

- a) Curves A
 - Select all remaining cur
 - All Selected
- d) Ok

6.4 Contact Bodies: Identify

If lines pointing to metal sheet side:

6.5 Tools: Flip Curves

- a) Select the cu
- b) All Selected

7. Loadcases

7. New: Static

- a) Total Loadcase Time: 0.5
- b) Steps: 50
- c) Converg Testing
 - Displacements
 - Relative Displacement Tolerance: 0.001
 - Ok
- d) Ok

7.2 In the tree copy the loadcase lcase1

7.3 Open l

- a) Total Loadcase Time: 0.5
- b) # Steps: 20
- c)

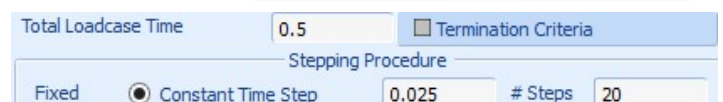
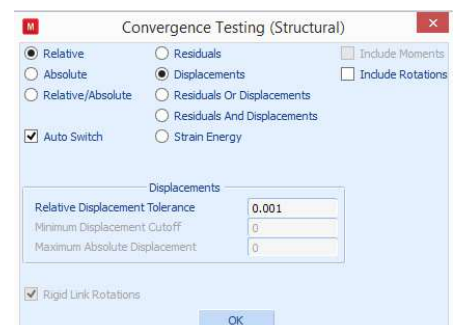
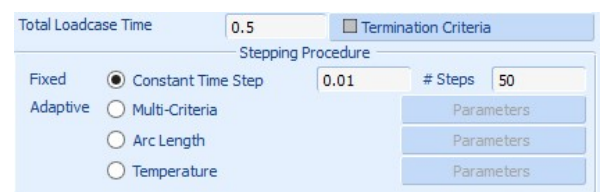
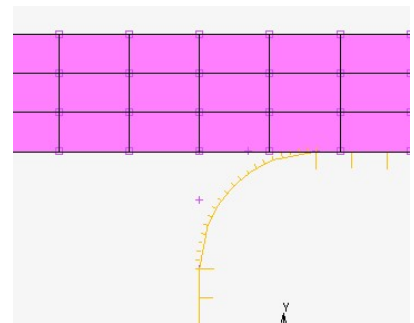
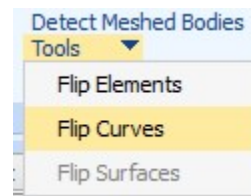
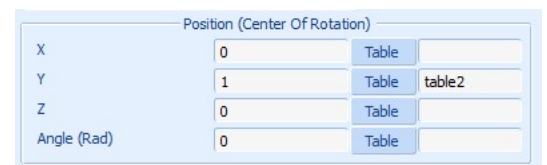
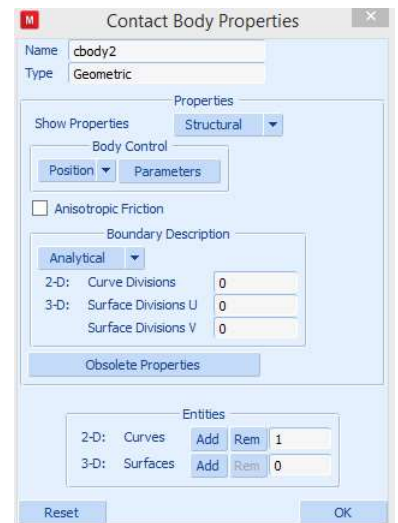

8. Jobs

8.1 New: Structural

a) Analysis Options

- Large Strain
- Ok

b) Select lcase1 and lcase2

c) Analysis Dimension: Plan Strain

d) Job Results

- Equivalent von Mises Stress
- Equivalent Plastic strain
- Ok

e) Contact Control

- Advanced Contact Control
- Separation Force: 0.1
- Ok

f) Run

- Submit (1)
- Monitor
- Ok

g) Ok

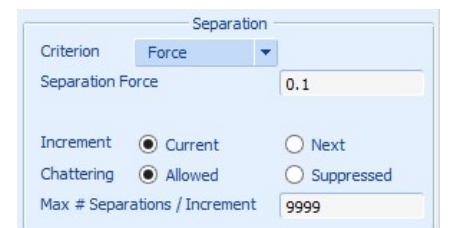
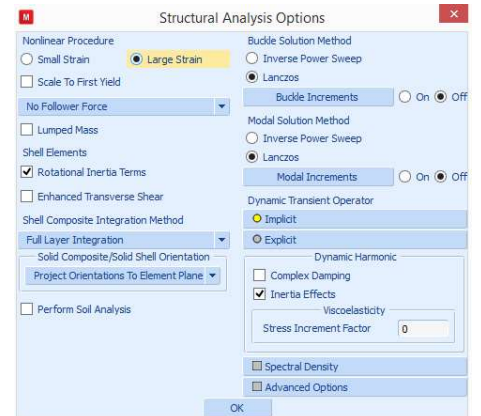

9. Results

9.1 File: Open D

9.2 Model Plot

a) Scalar: Total Equivalent Plastic Strain

b) Style: Contour Bands

c) Skip to Increment 50

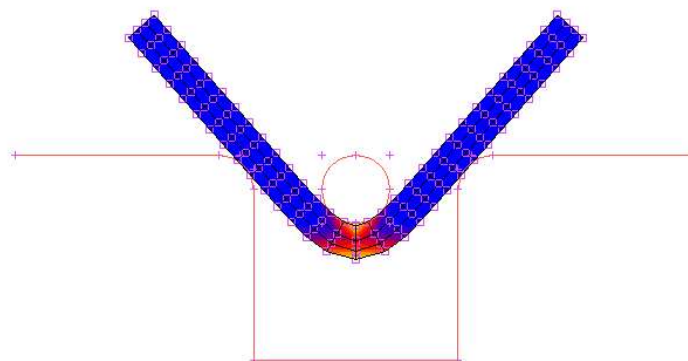
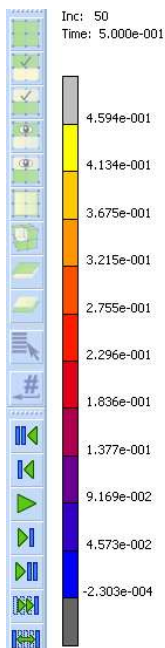

d) Skip to increment 70

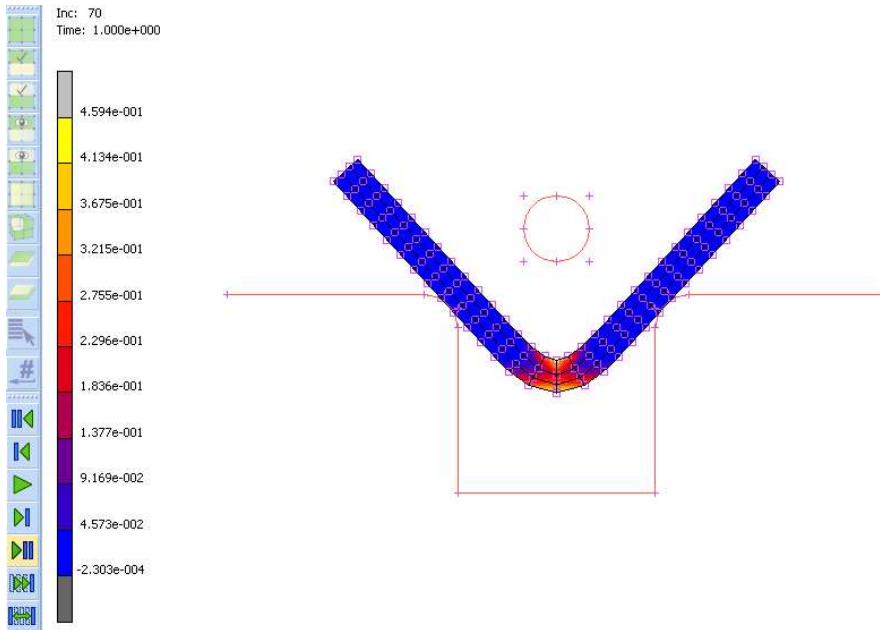

e) Ok

9.3 History Plot

a) Set Locations

- 63 Enter
- End List

b) All Incs

c) Add Curve

- Global
- Pos Y cbody2
- Force Y cbody 2
- Ok

d) Fit

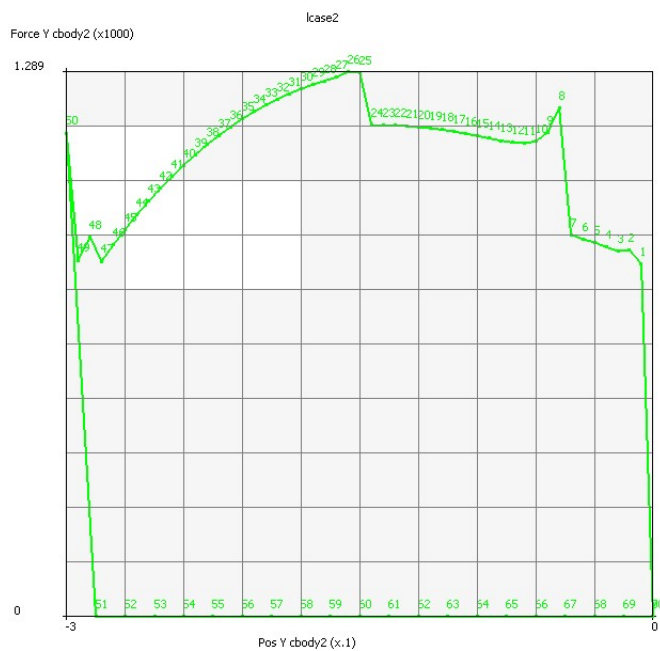

9.4 Clear Curves

9.5 All Incs

9.6 Add Curves

- All Locations
- Total Equivalent Plastic Strain
- Equivalent Von Mises Stress
- Ok

9.7 Fit

9.8 Ok

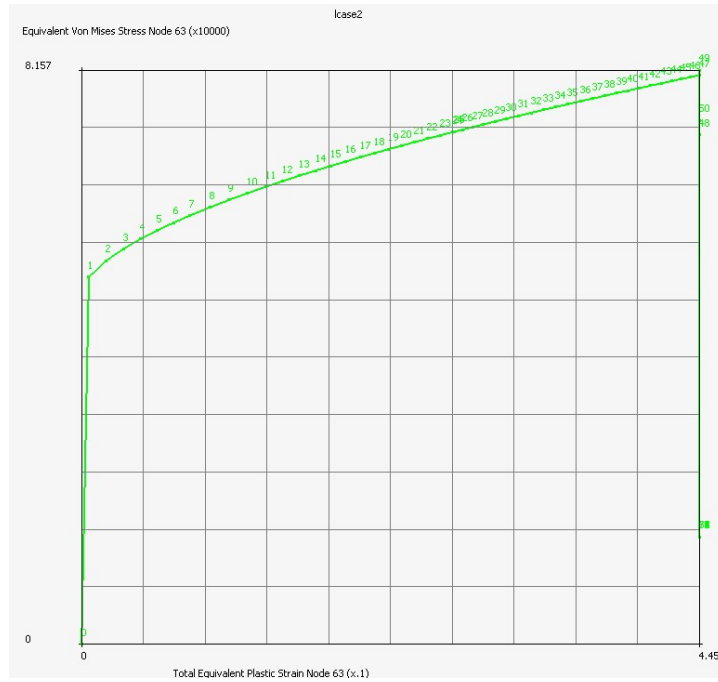

Discussion

Since the sheet completely wraps around the rigid cylinder at the end of the bending, we can estimate the strain assuming that the sheet completely surrounds the cylinder, and by knowing the strain, the stress can also be estimated as shown in Figure 3.9-12.

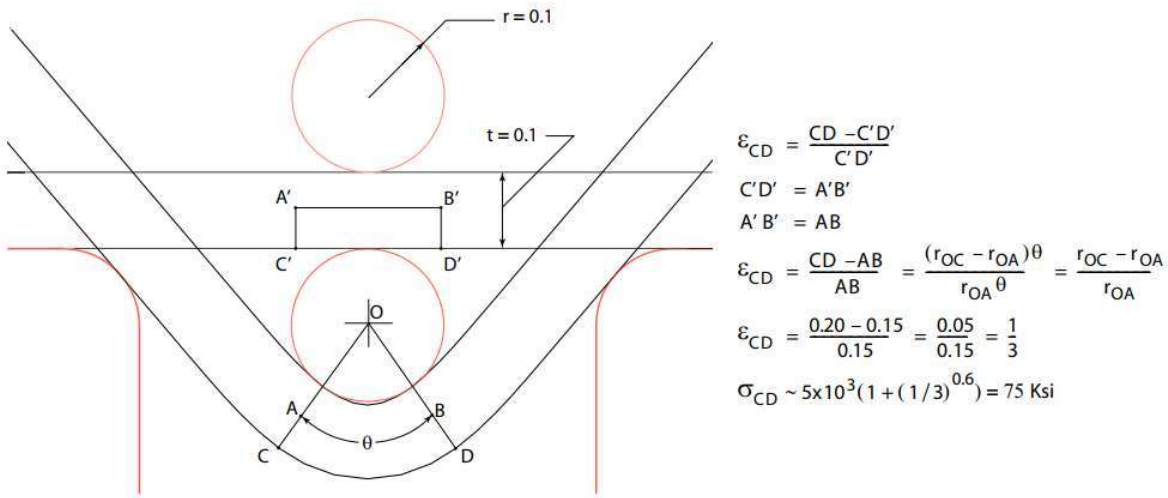

Figure 3.9-12 Estimating the Bending Strain and Stress in the Center of the Sheet

With the stresses estimated, we can assume that a fully plastic hinge forms in the center of the sheet and estimate the punch load as shown in Figure 3.9-13.

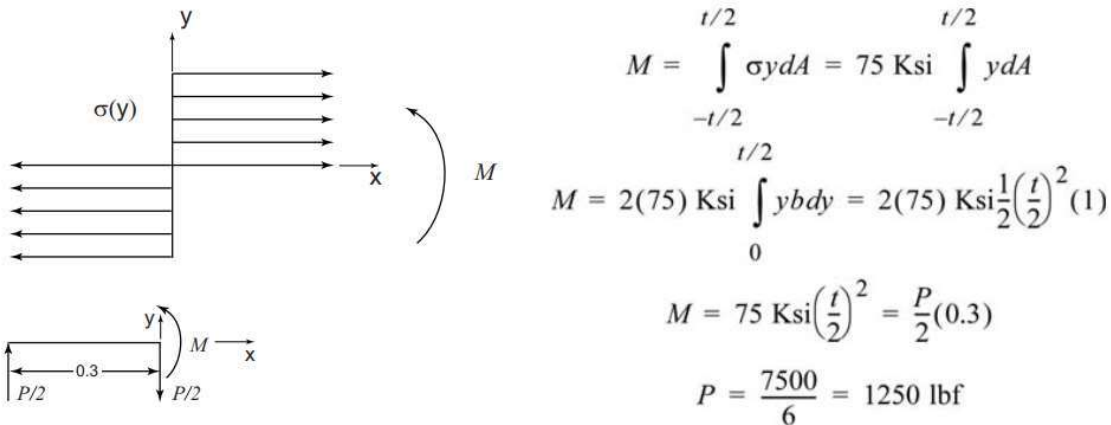

Figure 3.9-13 Estimating the bending moment and maximum punch load

The estimate for the maximum punch load, 1250 lbf, is very close to that found by the analysis as shown in Figure 3.9-10 of 1289 lbf. Finally, although the final angle after spring back appears close to 90° , its actual value is 84° , and the punch stroke should be slightly reduced to form a right angle after springback.